

SiC MOSFET driver power supply



RoHS



FEATURES

- Reinforced insulation
- I/O isolation test voltage: 5.0kVAC
- Partial Discharge 1700V
- Characterised CMTI>200kV/μs
- Max. Capacitive Load: 2200μF
- Ultra-low isolation capacitance: 3.5pF (typ.)
- High efficiency up to 87%
- SIP package
- Operating ambient temperature range: -40°C to +105°C
- Continuous short-circuit protection

QAxx3C-R3 is DC-DC module power supply designed for SiC MOSFET driver requiring two sets of isolation power supply. The mode of common ground outputs is adopted internally for better energy provision of SiC MOSFET turn-on and turn-off. Output short-circuit protection and self-recovery capabilities are also provided. General application includes:

1. Universal converter
2. AC servo drive system
3. Electric welding machine
4. Uninterruptible power supply (UPS)

Selection Guide

Certification	Part No.	Input		Output		Full Load Efficiency (%) Typ.	Max. Capacitive Load(μF)
		Voltage(VDC) (Range)	Current(mA, Typ.) Full Load/No Load	Voltage (VDC) +Vo1/+Vo2	Current (mA) +Io1/+Io2		
UL/EN	QA053C-1505R3	5 (4.5-5.5)	343/20	+15/-5	+80/-40	78/82	1000
	QA053C-2004R3	5 (4.5-5.5)	407/18	+20/-4	+80/-40		470
	QA053C-1803R3	5 (4.5-5.5)	415/20	+18/-3.5	+80/-80		680
	QA123C-1502R3	12 (10.8-13.2)	167/8	+15/-2.5	+100/-100	82/87	2200
	QA123C-1803R3	12 (10.8-13.2)	200/8	+18/-3			1000
	QA123C-1504R3	12 (10.8-13.2)	215/8	+15/-4	+120/-120	82/87	2200
	QA153C-1504R3	15 (13.5-16.5)	171/8				2200
	QA243C-1504R3	24 (21.6-26.4)	131/10	+20/-5	+90/-90	82/87	2200
	QA123C-2005R3	12 (10.8-13.2)	213/14				470
	QA153C-2005R3	15 (13.5-16.5)	167/8				2200
	QA243C-2005R3	24 (21.6-26.4)	129/11			76/81	2200

Note:*The specified maximum capacitive load for positive and negative output is identical.

Input Specifications

Item	Operating Conditions			Min.	Typ.	Max.	Unit
Input Voltage (1sec. max.)	Vin=5VDC	DC		-0.7	--	9	VDC
	Vin=12VDC	DC		-0.7	--	18	
	Vin=15VDC	DC		-0.7	--	21	
	Vin=24VDC	DC		-0.7	--	30	

Input Filter		Capacitance Filter
Hot Plug		Unavailable

Output Specifications

Item	Operating Conditions		Min.	Typ.	Max.	Unit	
Output Voltage	QA053C-1505R3	+Vo	Vin=5VDC, Pin6 & Pin7 +Io= +80mA	14.55	15.3	16.05	VDC
		-Vo	Vin=5VDC, Pin5 & Pin6 -Io= -40mA	-4.45	-4.7	-4.95	
	QA053C-2004R3	+Vo	Vin=5VDC, Pin6 & Pin7 +Io= +80mA	18.8	19.8	20.8	
		-Vo	Vin=5VDC, Pin5 & Pin6 -Io= -40mA	-3.8	-4	-4.2	
	QA053C-1803R3	+Vo	Vin=5VDC, Pin6 & Pin7 +Io= +80mA	16.74	17.64	18.54	
		-Vo	Vin=5VDC, Pin5 & Pin6 -Io= -80mA	-3.13	-3.3	-3.67	
	QA123C-1502R3	+Vo	Vin=12VDC, Pin6 & Pin7 +Io= +100mA	13.86	14.61	15.36	
		-Vo	Vin=12VDC, Pin5 & Pin6 -Io= -100mA	-2.28	-2.40	-2.53	
	QA123C-1803R3	+Vo	Vin=12VDC, Pin6 & Pin7 +Io= +100mA	17.10	18.00	18.90	
		-Vo	Vin=12VDC, Pin5 & Pin6 -Io= -100mA	-3.00	-3.15	-3.30	
	QA123C-1504R3	+Vo	Vin=12VDC, Pin6 & Pin7 +Io= +120mA	14.25	15.00	15.75	
		-Vo	Vin=12VDC, Pin5 & Pin6 -Io= -120mA	-3.60	-3.80	-4.00	
	QA123C-2005R3	+Vo	Vin=12VDC, Pin6 & Pin7 +Io= +90mA	18.50	19.50	20.50	
		-Vo	Vin=12VDC, Pin5 & Pin6 -Io= -90mA	-4.95	-5.20	-5.45	
	QA153C-1504R3	+Vo	Vin=15VDC, Pin6 & Pin7 +Io= +120mA	13.76	14.51	15.26	
		-Vo	Vin=15VDC, Pin5 & Pin6 -Io= -120mA	-3.80	-4.00	-4.20	
	QA153C-2005R3	+Vo	Vin=15VDC, Pin6 & Pin7 +Io= +90mA	18.50	19.50	20.50	
		-Vo	Vin=15VDC, Pin5 & Pin6 -Io= -90mA	-4.95	-5.20	-5.45	
	QA243C-1504R3	+Vo	Vin=24VDC, Pin6 & Pin7 +Io= +120mA	14.55	15.30	16.05	
		-Vo	Vin=24VDC, Pin5 & Pin6 -Io= -120mA	-3.96	-4.16	-4.36	
QA243C-2005R3	+Vo	Vin=24VDC, Pin6 & Pin7 +Io= +90mA	19.00	20.00	21.00		
	-Vo	Vin=24VDC, Pin5 & Pin6 -Io= -90mA	-4.75	-5.00	-5.25		
Voltage Accuracy		10% - 100% load	See output regulation curve (Fig. 3 to24)				
Linear Regulation	5V Input model	Full voltage input range	+Vo Output	--	±1.1	±1.4	--
			-Vo Output	--	±1.1	±1.4	
	Other model		+Vo Output	--	±1.1	±1.5	
			-Vo Output	--	±1.1	±1.5	
Load Regulation	5V Input model	10% - 100% load	+Vo Output	--	8	15	%
			-Vo Output	--	10	15	
	QA123C-1502R3		+Vo Output	--	8	17	
			-Vo Output	--	13	17	
	Other model		+Vo Output	--	6	15	
			-Vo Output	--	8	15	
Temperature Coefficient		Full load	--	±0.04	±0.1	%/°C	
Ripple & Noise*	5V Input model	20MHz bandwidth	--	50	150	mVp-p	
	Other model		--	50	100		
Short-circuit Protection		Continuous, self-recovery					

Note:* The "parallel cable" method is used for Ripple and Noise test, please refer to DC-DC Converter Application Notes for specific information.

General Specifications

Item	Operating Conditions	Min.	Typ.	Max.	Unit
Isolation	Input-output, Test for 1 minute with a leakage	5000	--	--	VAC

	current of 1mA max				
Partial Discharge	Input- output (According to IEC61800-5-1)	1700	--	--	V
CMTI	Input- output	±200	--	--	kV/μs
Insulation Resistance	Input-output resistance at 500VDC	1000	--	--	MΩ
Isolation capacitor	Input- output, capacitor at 100kHz/0.1V	--	3.5	5	pF
Operating Temperature	Derating when operating temperature ≥85°C, (see Fig. 2)	-40	--	105	°C
Storage Temperature		-55	--	125	
Pin Soldering Resistance Temperature	Soldering spot is 1.5mm away from case for 10s seconds	--	--	300	
Case Temperature Rise	Ta=25°C, nominal input voltage, full load	--	30	60	
Storage Humidity	Non-condensing	5	--	95	%RH
Switching Frequency	Full load, nominal input voltage	--	200	--	kHz
Safety Standard		UL62368-1 & EN62368-1 (Report)			
Safety Class		CLASS III			
MTBF	MIL-HDBK-217F@25°C	3500	--	--	k hours

Mechanical Specifications

Case Material	Black plastic; flame-retardant and heat-resistant
Dimensions	19.50 x 9.80 x 12.50mm
Weight	4.3g(Typ.)
Cooling Method	Free air convection

Electromagnetic Compatibility (EMC)

Emissions	CE	5V Input model	CISPR32/EN55032	CLASS B (see Fig. 33 for recommended circuit)
		Other Input model	CISPR32/EN55032	CLASS A (see Fig. 32 for recommended circuit)
	RE	5V Input model	CISPR32/EN55032	CLASS A (see Fig. 32 for recommended circuit)
		Other Input model	CISPR32/EN55032	CLASS B (see Fig. 33 for recommended circuit)
Immunity	ESD	5V Input model	IEC/EN61000-4-2	Contact ±6kV perf. Criteria B
		Other Input model	IEC/EN61000-4-2	Contact ±8kV perf. Criteria B

Typical Characteristic Curves

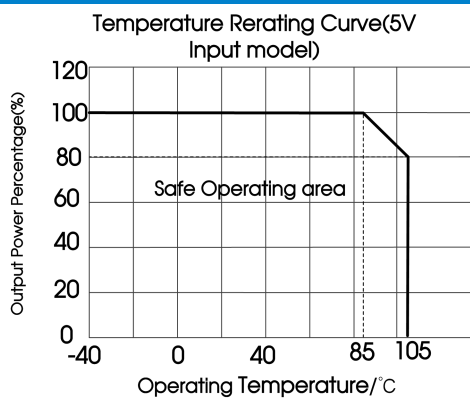

Fig. 1

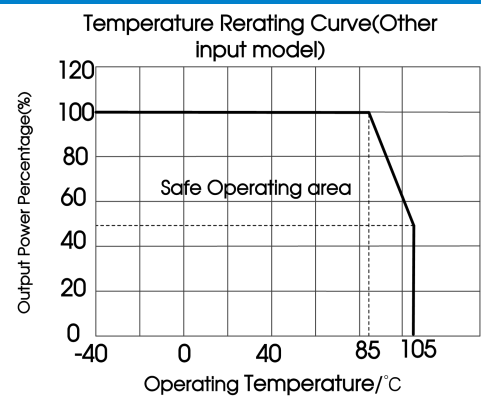

Fig. 2

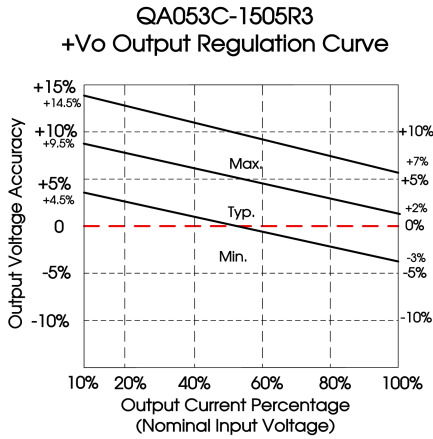

Fig. 3

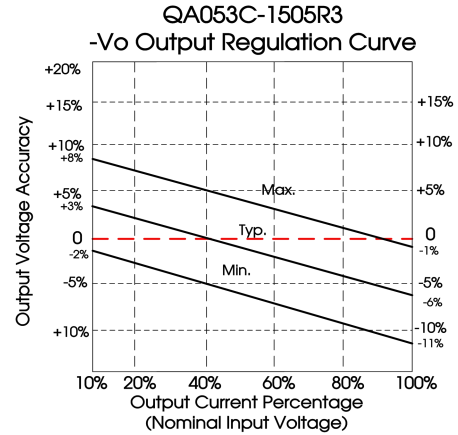

Fig. 4

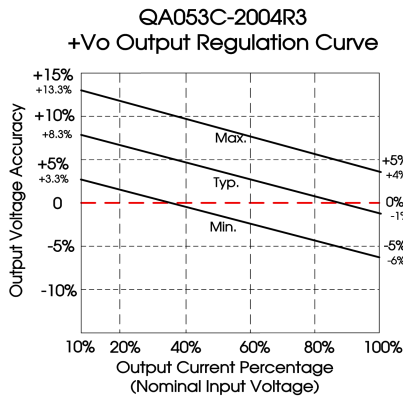

Fig. 5

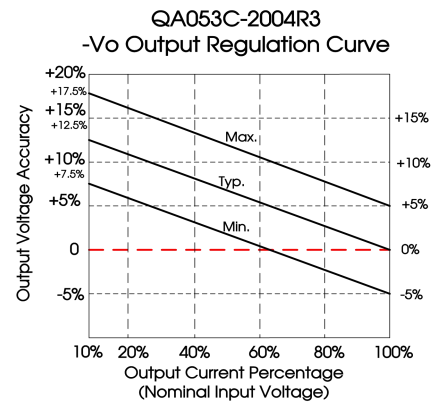

Fig. 6

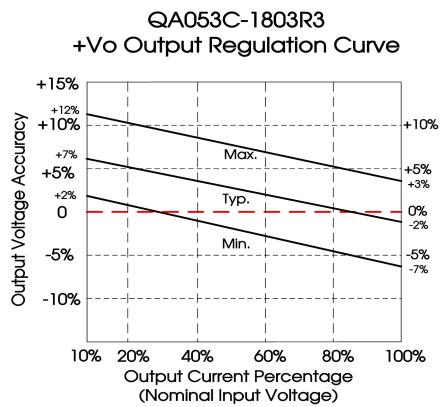

Fig. 7

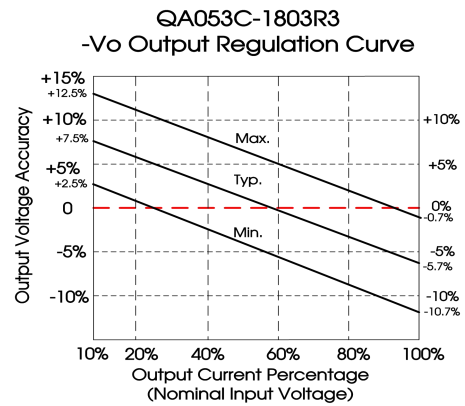

Fig. 8

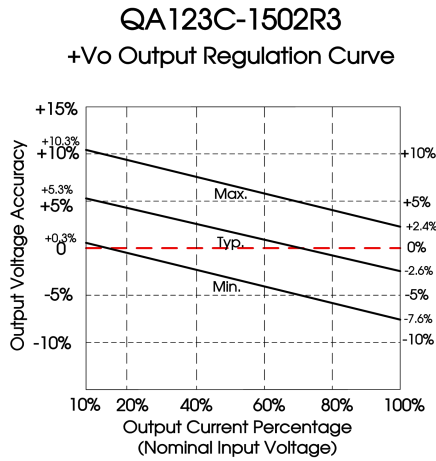

Fig. 9

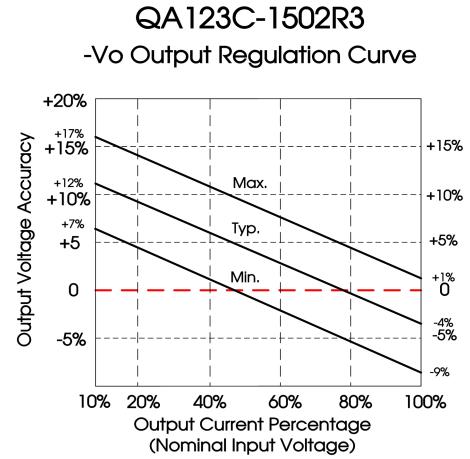

Fig. 10

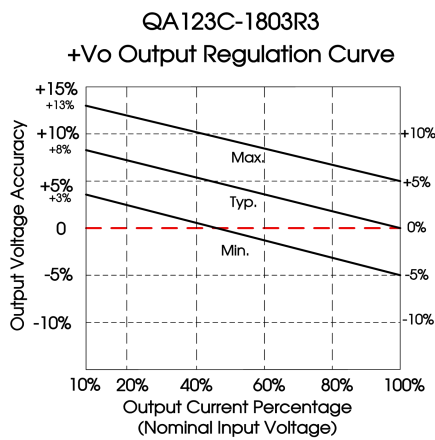

Fig. 11

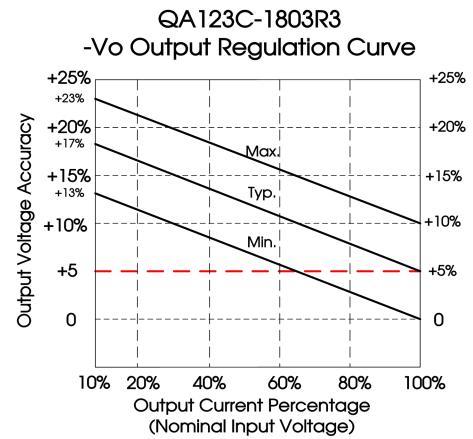

Fig. 12

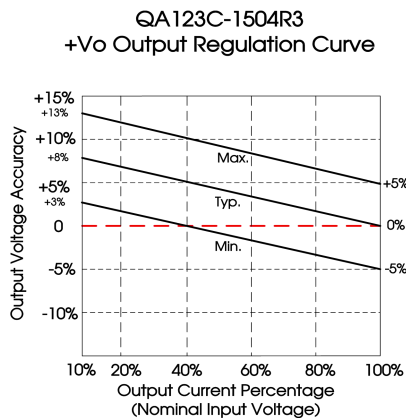

Fig. 13

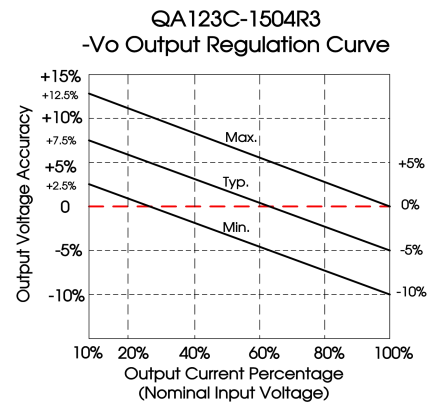

Fig. 14

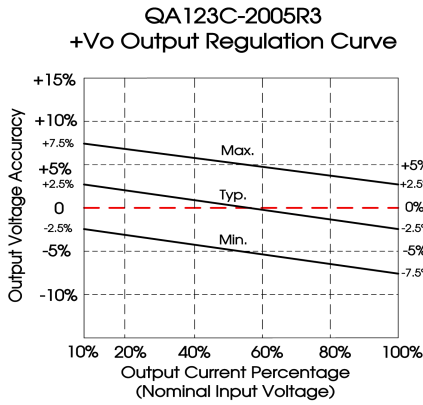

Fig. 15

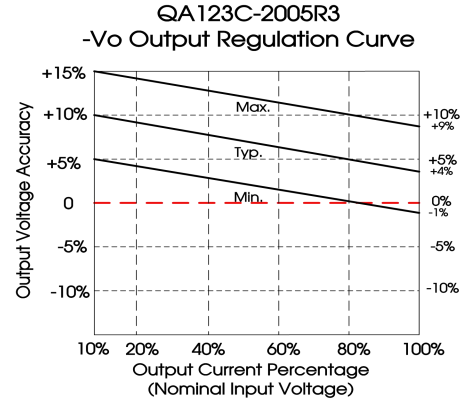

Fig. 16

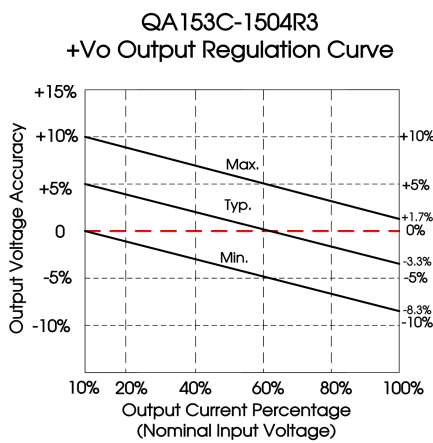

Fig. 17

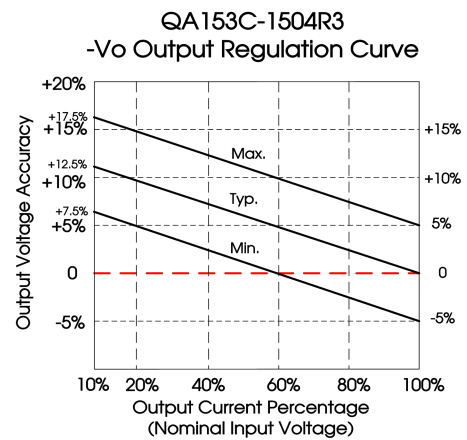

Fig. 18

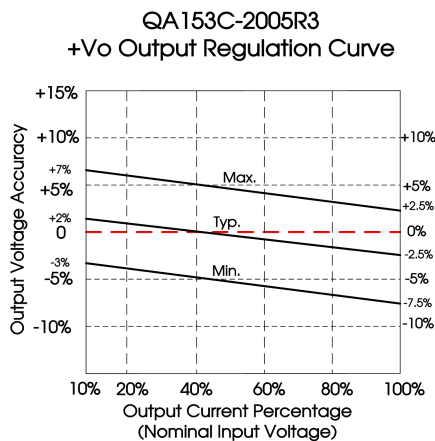

Fig. 19

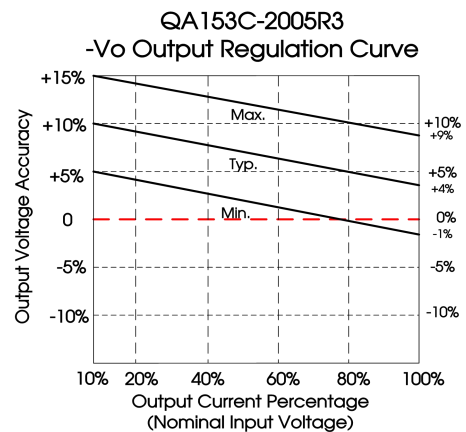

Fig. 20

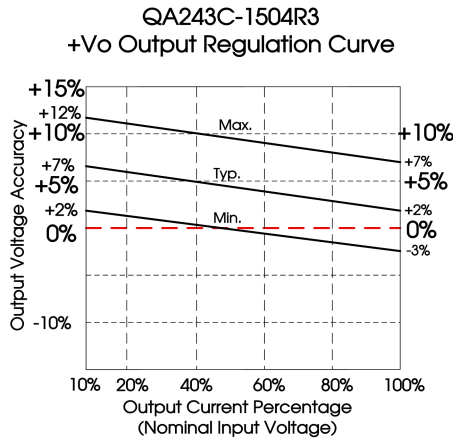

Fig. 21

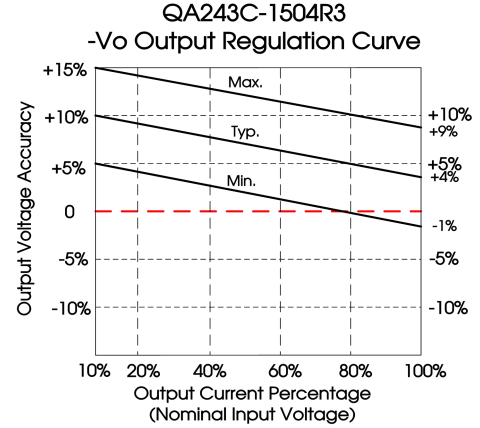

Fig. 22

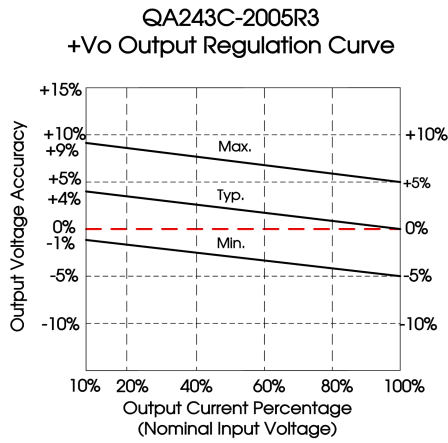

Fig. 23

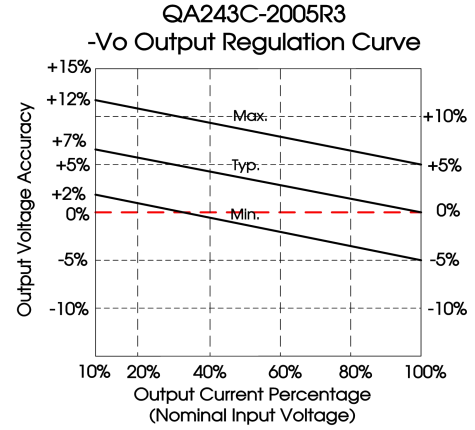

Fig. 24

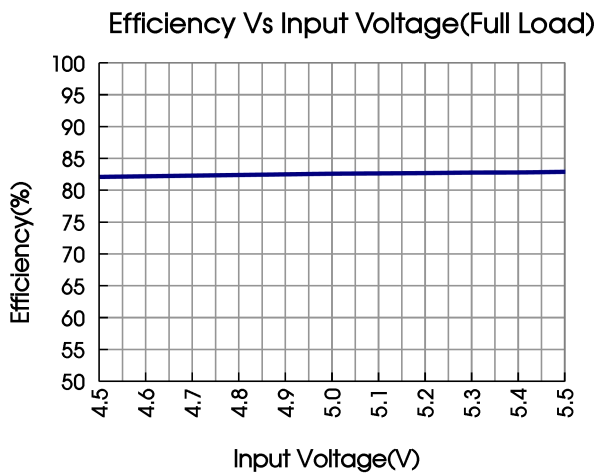

Fig. 25

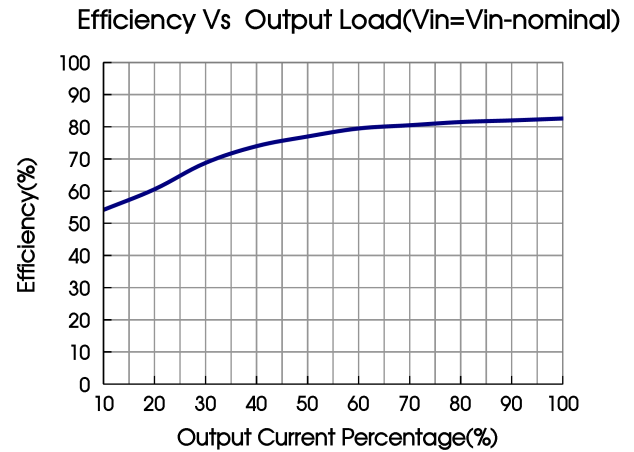

Fig. 26

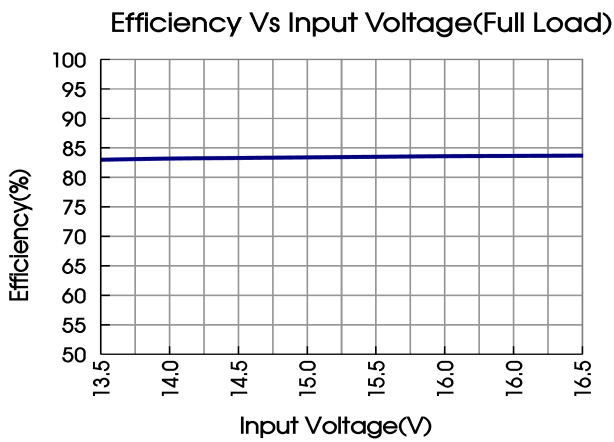

Fig. 27

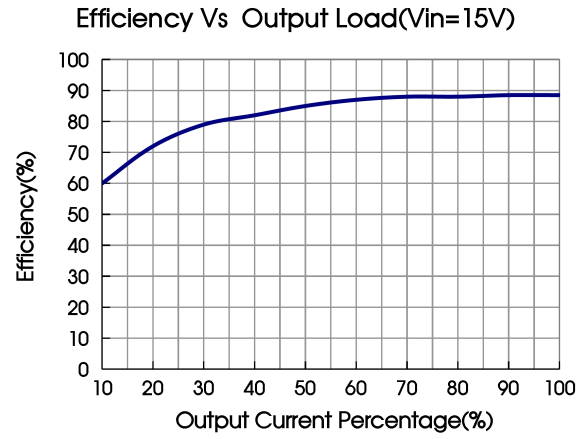

Fig. 28

Note: Take QA053C-1505R3 and QA153C-2005R3 as an example, other models can be corresponding reference

Design Reference

1. Test configurations

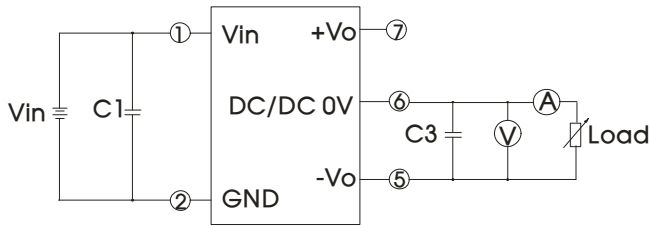

Fig. 29

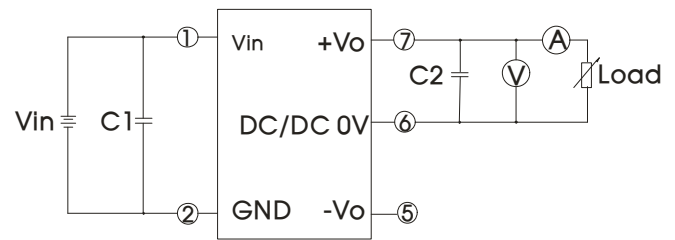

Fig. 30

Note: C1, C2, C3: 100 μ F/35V(Low internal resistance)

2. Typical application

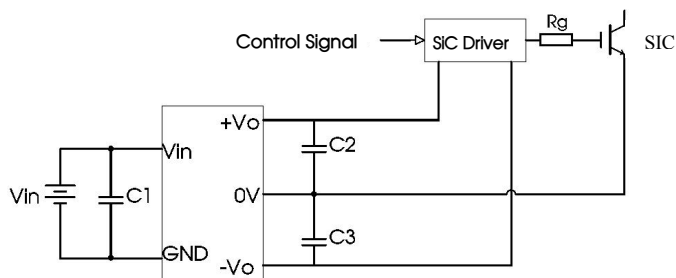

Fig. 31

C1/C2/C3
100 μ F/35V(Low resistance)

3. EMC typical recommended circuit

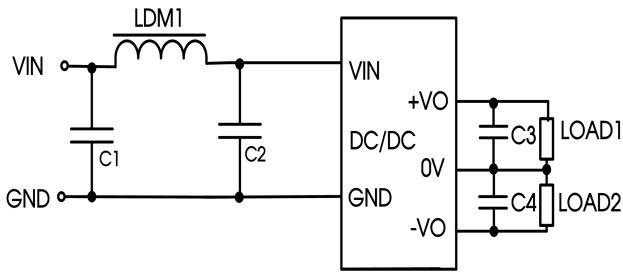

Fig. 32

Device selection			
Project		5V Input model	Other Input model
EMI	C1/C2	4.7μF /16V	1μF/50V
	C3/C4	10μF /50V (Low resistance)	100μF/30V (Low resistance)
	LDM	6.8μH	33μH

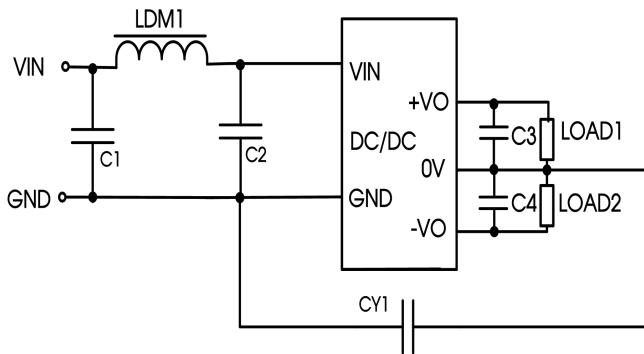

Fig. 33

Device selection (5V Input model)			
EMI	C1/C2	4.7μF /16V	
	C3/C4	10μF /50V (Low resistance)	
	LDM	6.8μH	
	CY1	330pF	

4. Electrolytic capacitors are recommended for external capacitors at the input or output of the product. Tantalum capacitors are not, otherwise there is a risk of failure.
5. The products do not support parallel connection of their output for power expansion purpose or hot-plug.
6. For more information please find the application notes on www.mornsun-power.com

Dimensions and Recommended Layout

THIRD ANGLE PROJECTION 

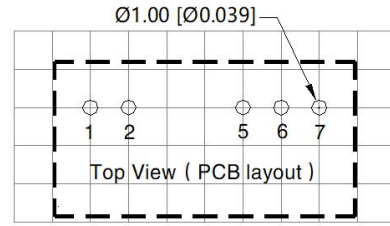
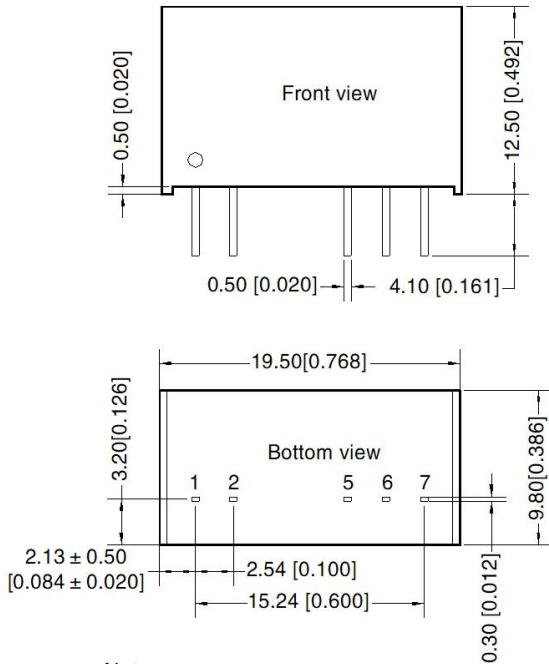

Pin-Out	
Pin	Mark
1	Vin
2	GND
5	-Vo
6	0V
7	+Vo

Note:
 Unit: mm[inch]
 Pin section tolerances: ±0.10[±0.004]
 General tolerances: ±0.50[±0.020]

Notes:

- For additional information on Product Packaging please refer to www.mornsun-power.com. Packaging bag number: 58200013;
- The lead connecting the power supply module and SiC driver should be as short as possible during use;
- The output filtering capacitor should be as close as possible to the power supply module and SiC driver;
- The peak of the SiC driver gate drive current is high, so low internal resistance electrolytic capacitor is recommended to be used for the power supply module output filter capacitor;
- The average output power of the driver must be lower than that of the power supply module;
- Consider fixing with glue near the module if being used in vibration occasion;
- The maximum capacitive load offered were tested at nominal input voltage and full load;
- Unless otherwise specified, parameters in this datasheet were measured under the conditions of Ta=25°C, humidity<75%RH with nominal input voltage and rated output load;
- All index testing methods in this datasheet are based on company corporate standards;
- The above are the performance indicators of the product models listed in this datasheet. Some indicators of non-standard models will exceed the above requirements. For details, please contact our technical staff;
- We can provide product customization service, please contact our technicians directly for specific information;
- Products are related to laws and regulations: see "Features" and "EMC".
- Our products shall be classified according to ISO14001 and related environmental laws and regulations, and shall be handled by qualified units

MORNSUN Guangzhou Science & Technology Co., Ltd.

Address: No. 5, Kehui St. 1, Kehui Development Center, Science Ave., Guangzhou Science City, Huangpu District, Guangzhou, P. R. China
 Tel: 86-20-38601850 Fax: 86-20-38601272 E-mail: info@mornsun.cn www.mornsun-power.com